

Cod. D114745

DOP-No 14527

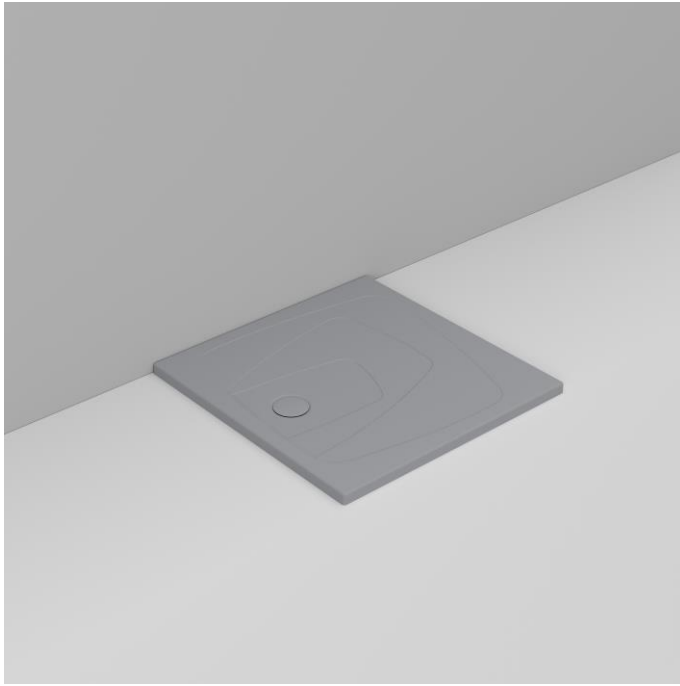

Ultra thin H. 4 cm. Suitable for floor standing or floor recessed installation. Anti-slip pattern. Waste towards left.
To be completed with syphon-waste to be separately ordered.

Colour	Concrete Grey
Width (mm)	900
Depth (mm)	900
Height (mm)	43
Weight (Kg)	35,3
Installation	floor recessed and floor standing installation
Installation note: instructions at following page	

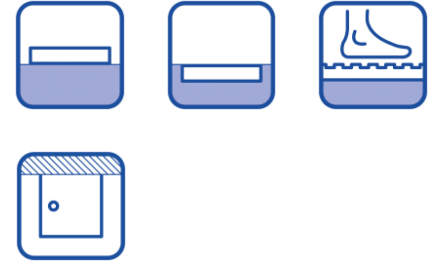

available colours:

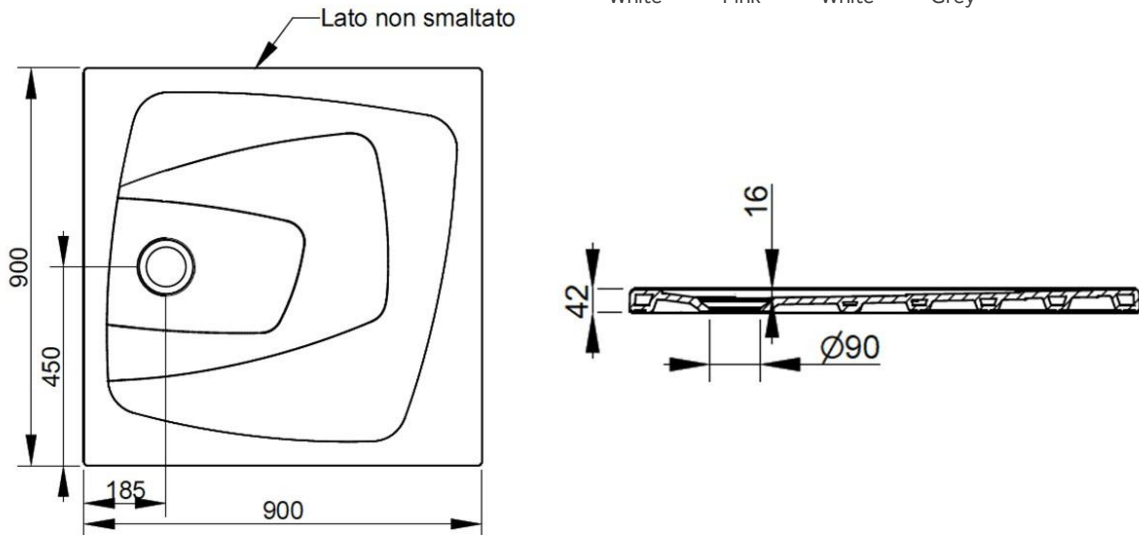

NOT PROVIDED FIXINGS / ACCESSORIES / SPARE

(* Mandatory)



V100245
Syphon-waste 90 mm.
ceramic plated



V100845
Cover for waste V1002
ceramic plated

ASSEMBLY INSTRUCTIONS

1



Position the waste according to the existing drain hole and according to the position in the bathroom. Supporting points should be made using low water mortar alongside the corners as well as the centre.

2



We advice you to use a nylon or paper sheet to avoid that mortar could glue to ceramic.

3

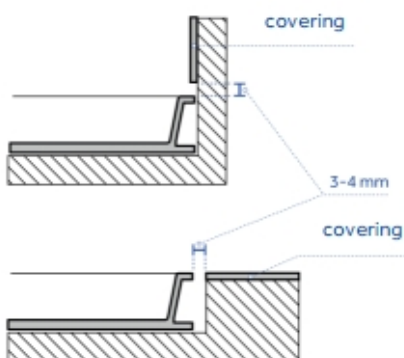

Position the shower tray paying attention to the thickness of the covering (or to the floor thickness in case of recessed installation) and leaving a gap of 3-4 mm.

Covering should not weigh on the shower tray edge: in case of building setting-up it could cause breaks.

4

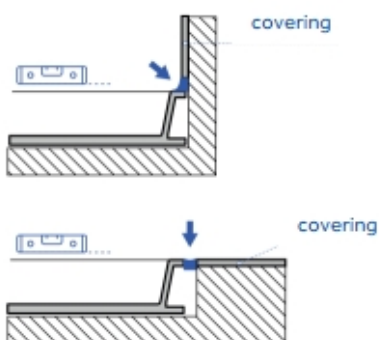

Verify the right horizontal positioning by means of a spirit level.

Complete installation by sealing with white, anti-mould silicon or elastic mortar.